



An ITW Company

IONIZATION SOLUTIONS



Extended Coverage Ionizing Blower

Aerostat® XC2

User's Manual

About Simco-Ion

Simco-Ion develops, manufactures, and markets system solutions to manage electrostatic charge. As the world's largest provider of electrostatics management products and services, Simco-Ion improves its customers' business results by providing a total solution to their electrostatic discharge challenges. Simco-Ion Technology Group is a division of Illinois Tool Works (ITW), located in Alameda, California. For more information about Simco-Ion visit www.simco-ion.com or call +1 800-367-2452. Simco-Ion is ISO 9001-2008 certified.

Ion Systems' logo  is a registered trademark of Simco-Ion, An ITW Company.

© 2017 Ion Systems. Printed in the USA.

© 2017 Simco-Ion

Important Safety Information



Carefully read the following safety information before installing or operating the equipment. Failure to follow these safety warnings could result in damage to your ionization system and/or voiding the product warranty.

- The use of improper input voltage may result in poor performance or damage to the ionizer. This will also void the warranty.
- This product is supplied with a 3-prong grounding plug, which must be inserted in an appropriate, properly wired and grounded receptacle. Do not defeat the electrical ground. For safety, the use of extension cords is not recommended.
- Do not use this Blower in an explosive environment. Poorly maintained Ionizers could produce miniscule electric arcs along the emitter. This may cause detonation in an explosive environment. Read **Section 1.4 Power Requirements** and **Section 3.1 Operating Environment** before applying power to the unit.
- To avoid personal injury or damage to the equipment, do not perform any maintenance other than that contained in these instructions. Do not insert anything within the intake or outlet grills.
- There are no user-replaceable parts inside this blower other than the emitter cartridge and the power fuse. Any unauthorized service will void the warranty and may result in additional repair charges. Contact your local Simco-Ion representative if the blower requires service or repair.
- For in-door use only in a non-condensing environment.
- This product is not intended for use in tropical climate regions or for use at altitudes above 2000m.

- ☑ Before performing any recommended maintenance, be sure the unit is powered off and unplugged.
- ☑ To insure user safety when operating the Aerostat XC2, do not point the blower face any lower than 45° from horizontal.

Informations de Sécurité Importantes



Lisez attentivement les consignes de sécurité suivantes avant d'installer ou d'utiliser l'équipement. Le non-respect de ces avertissements peut entraîner des dommages à votre système d'ionisation et/ou d'annuler la garantie du produit.

- ☑ L'utilisation d'une mauvaise tension d'entrée peut entraîner de mauvais résultats ou de détérioration de l'ioniseur. Ce sera également annuler la garantie.
- ☑ Ce produit est fourni avec un 3-broches fiche de mise à la terre, qui doit être insérée dans un accès approprié et correctement câblé et mis à la terre prise. Ne pas défaire la mise à la terre électrique. Pour des raisons de sécurité, l'utilisation de cordons d'extension n'est pas recommandée.
- ☑ Ne pas utiliser ce ventilateur dans un environnement explosif. Mal entretenu ioniseurs pourrait produire infime arcs électriques le long de l'émetteur. Cela peut provoquer de la détonation dans un environnement explosif. Lisez la Section 1.4 Exigences en matière d'alimentation et Section 3.1 Environnement d'exploitation avant d'appliquer la tension de l'unité.
- ☑ Pour éviter tout risque de blessure ou de détérioration du matériel, n'effectuez aucune opération d'entretien autres que celles contenues dans ces instructions. N'introduisez rien dans le collecteur d'admission ou de sortie des barbecues.
- ☑ Il n'y a aucune pièces remplaçables par l'utilisateur au sein de cette soufflerie autres que l'émetteur cartouche et le fusible d'alimentation. Tout service non autorisé annulera la garantie et peut entraîner des charges de réparation. Contactez votre représentant Simco-Ion si le surpresseur requiert un entretien ou réparation.
- ☑ Pour une utilisation sur porte uniquement dans une non-condensation environnement.

- ☑ Ce produit n'est pas destiné à être utilisé dans les régions au climat tropical ou pour l'utilisation à des altitudes au-dessus de 2000m.
- ☑ Avant d'effectuer tout entretien recommandé, assurez-vous que l'appareil est hors tension et débranchée.
- ☑ Pour assurer la sécurité de l'utilisateur lors de l'utilisation du Aerostat XC2, ne pointez pas le visage de soufflante inférieure à 45° de l'horizontale

Contents

1 Description	1
1.1 Product Description.....	2
1.2 Product Features	3
1.3 Performance	5
1.4 Power Requirements	6
2 Installation & Setup.....	7
2.1 Box Contents	9
2.2 Mounting & Placement.....	9
2.3 Power Connections.....	10
3 Operation	13
3.1 Operating Environment.....	14
3.2 Controls & LED Indicators.....	15
3.3 Balance	17
3.4 Alarms.....	19
3.5 FMS Relay Contact.....	21
3.6 Optional Air Filter	22
4 Maintenance	23
4.1 Maintenance Scheduling.....	24
4.2 Emitter Cartridge Inspection & Cleaning.....	26
4.3 Chassis Cleaning	31
4.4 Troubleshooting	32
5 Specifications	35
5.1 Specifications.....	36
5.2 Dimensional Drawing	38
5.3 Parts & Accessories.....	39
6 Warranty & Service	40

1

Description

- 1.1 Product Description
- 1.2 Product Features
- 1.3 Performance
- 1.4 Power Requirements

1.1 Product Description

The Aerostat XC2 Extended Coverage Ionizing Blower is designed to meet a variety of applications where a wide static discharge coverage area is desired. Specific applications where the Aerostat XC2 performs well includes glass substrate handling in backend flat panel display processing and electronic subassembly workstations.

The Aerostat XC2 uses the Simco-Ion patented "Micropulse" Technology to meet the performance, particle cleanliness and low maintenance requirements that are necessary to maximize production yield in many applications.

The Aerostat XC2 is available with an optional heater to reduce the effects of wind-chill.

This manual covers the installation, operation and maintenance of the Aerostat XC2 Ionizing Blower.



Figure 1. Extended Coverage Ionizing Blower Model Aerostat XC2

1.2 Product Features

The Aerostat XC2 has the following unique features and benefits:

- Large area ionization footprint for complete discharge coverage across an extended work surface.
- Patented "Micropulse" Technology with high efficiency output that provides for long periods between maintenance cycles.
- Maintains a balance around zero of +/-10V or better.
- LED alarms for both ionization balance fault and fan status.
- Facility Monitoring System (FMS) relay contact for remote status monitoring.
- Employs a high efficiency, multi-speed fan to produce a strong ionized air flow.
- Push button cleaner for easy, periodic cleaning of emitters.
- Universal AC input accepts all IEC power cords.
- An audible alarm that sounds for all alarm conditions (an optional feature if ordered at time of XC2 purchase) available on the XC2-05A models.
- An optional heater for reducing the effects of wind-chill (an optional feature if ordered at time of XC2 purchase).

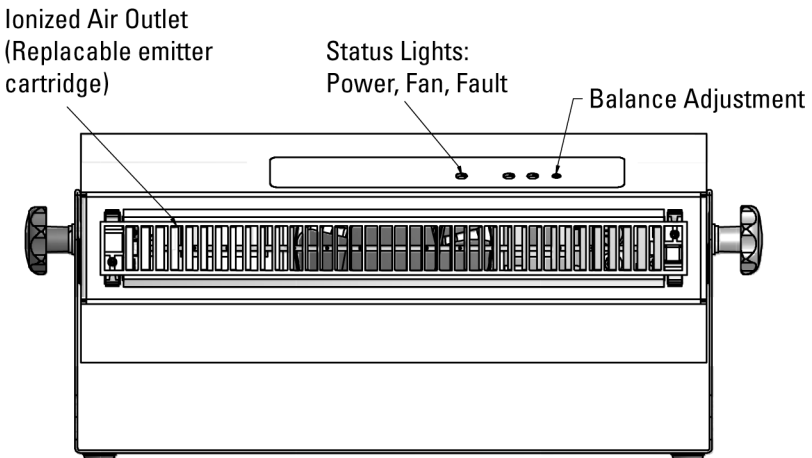

Figure 2. Aerostat XC2 Front-panel

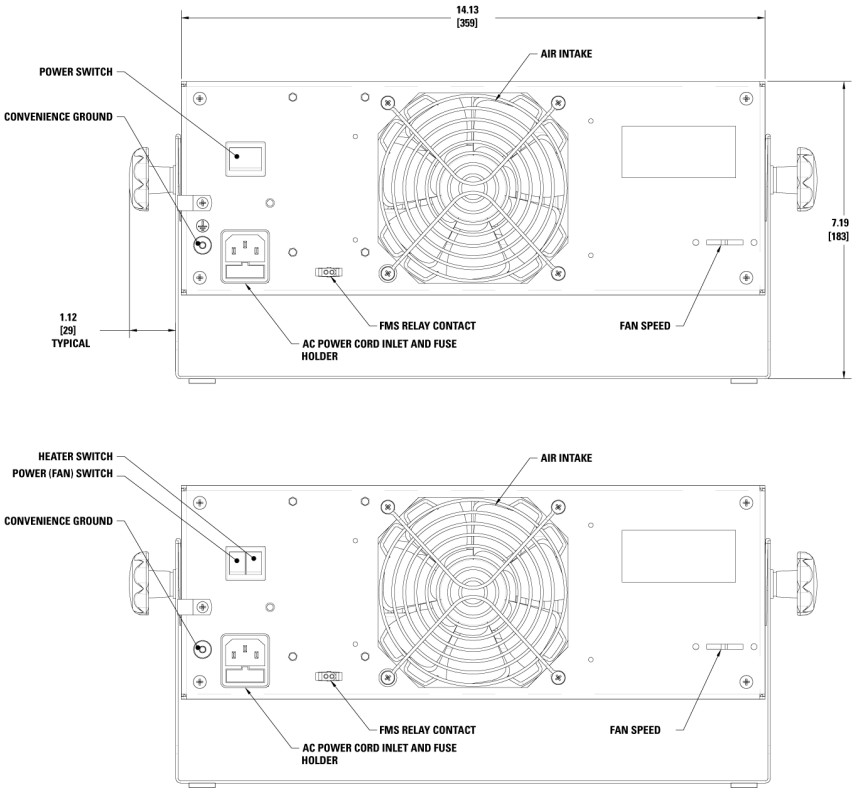

Figure 3. Aerostat XC2 Rear Panel (with heater and without heater)

1.3 Performance

The Model Aerostat XC2 is factory adjusted to meet the specifications in the centerline static discharge times below:

- 1.0 seconds or less @ 1' (30 cm)
- 2.0 seconds or less @ 2' (60 cm)
- 3.5 seconds or less @ 3' (90 cm)
- 5 seconds or less at @ 4' (122 cm)

These decay times are for directly in-line with the center of the fan, $\pm 1000V$ to $100V$. Measurements were taken at the stated distance at high fan speed using a charged plate monitor in accordance with ESD Association Ionization Standard ANSI/ESD STM3.1-2015. Discharge times may be improved when tested within your operating environment.

In a humidity-controlled environment, the XC2 will maintain a balance around zero of $\pm 10V$ or less. Performance in extreme environments may vary. When using the optional fan filter, the performance of the unit will be reduced between 10-40% depending upon speed of the blower and the distance to the target.

Coverage Area Discharge Time Specification

Discharge times are tested in accordance with ANSI/ESD STM3.1-2015. Each point identifies the 1000V to 100V discharge times (in seconds) with high fan/low fan speed across the target area. Times are slightly higher with 230V/50 Hz unit.

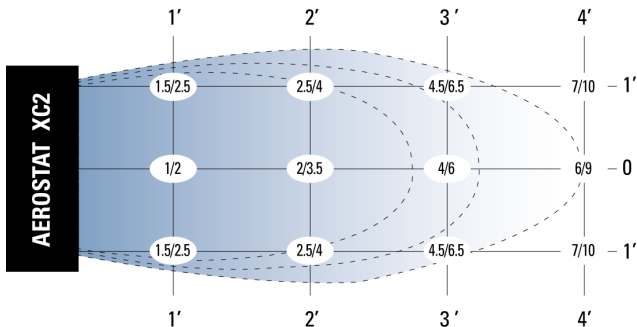

Figure 4. Aerostat XC2 Discharge Times

1.4 Power Requirements

The Aerostat XC2 is powered by an internal universal AC input power supply with an input line voltage range of 100 to 240 VAC, 50/60 Hz single phase.

Typical maximum current draw for the Aerostat XC2 at high fan speed:

- 100-240 VAC, 50/60 Hz, 0.5A, 55W max (no heater)
- 100-120 VAC, 50/60 Hz, 3.5A, 420W max (with heater)
- 220-240 VAC, 50 Hz, 1.9A, 460W max (with heater)

Caution:

The use of improper input voltage may result in poor performance or damage to the unit. Damage caused to the power supply from operation at levels outside of the specified limits will void the warranty.

Attention:

L'utilisation d'une mauvaise tension d'entrée peut entraîner de mauvais résultats ou endommager l'appareil. Les dommages causés à l'alimentation de fonctionnement à des niveaux en dehors des limites spécifiées entraînera l'annulation de la garantie.

2

Installation & Setup

- 2.1 Box Contents
- 2.2 Mounting & Placement
- 2.3 Power Connections

2.1 Box Contents

The Aerostat XC2 is packaged with the following items:

- Mounting Stand (installed on Blower)
- User Manual
- Certificate of Compliance
- Power cord
- Rubber feet for use on mounting stand (4 pieces)
- Cord clamp w/screw
- FMS connector mating plug & crimp contacts

2.2 Mounting & Placement

Initial Operation

Operate the Aerostat XC2 ionizer for an initial 24 hours in the area of application before any performance measurements are conducted.

The Aerostat XC2 should be placed approximately 1 to 4 feet (0.3 to 1.3m) from objects to be neutralized or from the critical work area. Although discharge times are longer the further away the target area is placed from the XC2, tests show that the XC2 will ionize the target area at further than 4 feet distance.

The XC2 should be positioned to cover as much of the area as possible with the ionized air stream. Keep at least a 6 inch clearance between walls or any objects and the rear of the XC2 to allow for adequate air intake.

Unit Mounting

The Aerostat XC2 comes with a mounting stand preassembled to the blower. The mounting stand is designed for a free or fixed position on a tabletop or workbench and also for mounting to a fixed surface. Self-adhesive skid-resistant rubber feet are supplied with the blower and can be installed on the bottom of the stand by the end-user. Holes in the base of the stand are provided for securing the XC2 to a fixed location using 5/16" (8 mm) diameter screw hardware (not provided).

Once the Aerostat XC2 is secured to a surface, the mounting stand can be adjusted and locked to a desired position. Loosen, but do not completely remove, the knobs on each side of the blower. Tilt the XC2 to the desired position so the XC2 ionized airstream is aimed directly at the target with no intervening grounded objects. Retighten the knobs to lock the XC2 into place.

2.3 Power Connections

Caution: To insure user safety when operating the Aerostat XC2, do not point the blower face any lower than 45° from horizontal.

The XC2 accepts universal AC input (100-230 VAC 50/60 Hz single phase). The XC2 must be grounded for safe and proper operation. The XC2 is available with different line cords to meet the main power connection plug requirements in many areas of the world. Connect the supplied power cord to an appropriate 3-terminal grounded AC power receptacle.

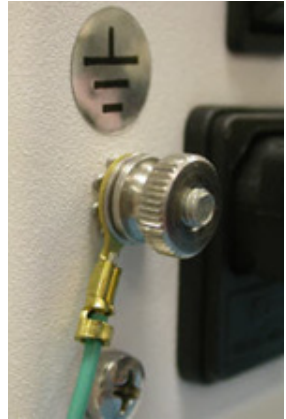

Figure 5. Ground Terminal

If the XC2 Blower will be installed in an environment that is electrically noisy, an additional ground connection can be made to the blower using the convenience ground terminal located on the rear panel of the blower.

A cord clamp is supplied with the blower. Use this cord clamp to prevent unwanted disconnection of the power cord or for protection against accidental loosening of the power cord due to vibration. After connecting the power cord to the power inlet connector, fit the power cord through the cord clamp and secure the clamp to the chassis rear panel with the supplied #6 sheet metal screw.

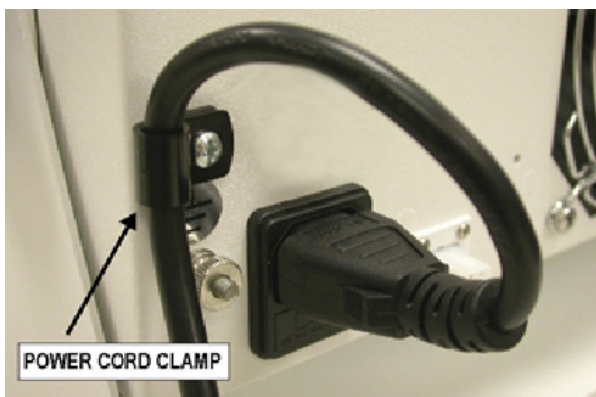

Figure 6. Power Cord Clamp

Warning:

Do not insert anything within the intake or outlet grills.
Electric shock may result.

Avertissement :

N'introduisez rien dans le collecteur d'admission ou de
sortie des barbecues. **Provoquer un choc électrique.**

3

Operation

- 3.1 Operating Environment
- 3.2 Controls & LED Indicators
- 3.3 Balance
- 3.4 Alarms
- 3.5 FMS Relay Contact
- 3.6 Optional Air Filter

3.1 Operating Environment

Operate the Model Aerostat XC2 in an environment where relative humidity is 30-60% (non-condensing). The operating temperature range for the Blower is 50-95°F (10-35°C).

The Model Aerostat XC2 will conform to stated performance specifications when used in an environment that meets the cleanliness limits defined by ISO 14644-1 Class 6 (Fed Std. 209E Class 1000) and if it is serviced according to an appropriate maintenance schedule.

3.2 Controls & LED Indicators

Fan Power

Power ON the XC2 by setting the FAN power switch on the rear panel to the ON position ("I"). The green LED POWER indicator light on the front panel will light and the fan will start up.

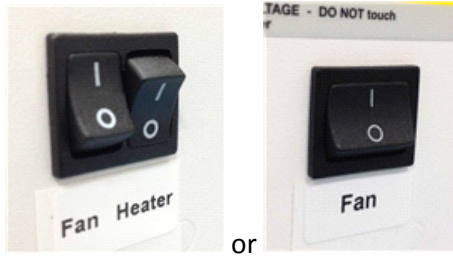

Fan Speed Adjustment

The airflow (fan speed) may be adjusted using the Fan Speed slide switch on the back of the Aerostat XC2. The XC2 fan can be set to Low, Medium or High.



Alarm

There are two red LED alarm indicators located on the front panel. FAN will indicate a stalled fan. FAULT will indicate a loss of high voltage at the emitters, when the emitter cartridge is removed from the Blower, or when ionization is out of balance.

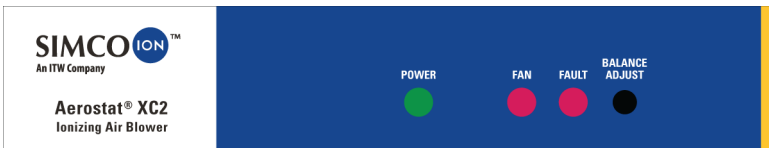

Figure 7. LED Indicator Lights

Heater (“H” Model Only)

Turn on the heater by setting the “HEATER” rocker switch to the on (“|”) position. NOTE: The heater will only operate when the fan is on.



The heater provides about a 2-3°C rise in temperature of the ionized air, at the face of the blower which is just enough to counter the effects of wind chill. The XC2 heater is not meant to act as a space heater.

If the HEATER switch is turned on and the FAN switch is turned off, the heater automatically stops. The XC2 heater is protected with thermal cutout devices that will deactivate the heater in the case of over heating, such as inadequate air flow due to a failed fan.

3.3 Balance

The AeroStat XC2 has a balance adjust control for setting the initial balance of the blower. The internal feedback control system will then maintain the balance of the XC2 to +/-10V around the initial balance set point.

The AeroStat XC2 leaves the factory with the Balance adjust control set to meet performance specifications during final factory test. For optimal performance, it is recommended that the XC2 balance setting be checked and adjusted (if required) by the end user prior to using the blower. A Charged Plate Monitor (CPM) with a standard 6"x6" plate, such as the Simco-Ion Model 280A, is required to monitor the balance of the ionizer during the balance adjustment procedure.

It is recommended that the XC2 should be allowed to run and acclimatize for an initial 24 hours in an environment comparable to the area of application before any performance measurements are conducted.

1. Set the XC2 fan to the desired speed.
2. Place a Charged Plate Monitor at a distance of about 12" (300 mm) directly in front of the blower with the CPM plate positioned in the ionized air stream. Turn on the CPM and set it for balance monitoring. Observe the balance reading displayed by the CPM.
3. Use a trimpot tool or small flat blade screw driver to adjust the "Balance" control on the front panel of the XC2. Turning the balance adjust control clockwise will make the balance voltage more positive. Turning the control counterclockwise will make the balance more negative.

The XC2 should be adjusted so that the CPM displays a balance of approximately 0V +/-5V.

For optimum balance performance, Simco-Ion recommends using the push button emitter point cleaner daily. This will insure the Aerostat XC2 is fully emitting the maximum volume of ions onto your target area.

The Aerostat XC2 blower should be OFF when using the push button emitter point cleaner. Do not clean the emitter points while the blower is operating.

3.4 Alarms

There are 2 red LED indicators located on the front panel:

1. FAN: When constantly lit, the fan is not rotating properly (stalled fan). This alarm will clear itself if the fan is able to resume normal operation.
2. FAULT:
 - Constantly lit: No high voltage on the emitters or the emitter assembly is removed from the Blower. A constant FAULT indicator can be cleared by correcting the fault condition and cycling the power to the blower OFF and ON again.
 - Blinking: High voltage is ON but \pm ionization is not balanced. A blinking FAULT indicator will clear itself if the ionization balance condition is corrected (suggestion: clean the emitter points by pressing the emitter point cleaner button).

Condition	LED Status Indicators			FMS Relay Output	Ionization Voltage State
	POWER (Green)	FAN (Red)	FAULT (Red)		
Power OFF	OFF	OFF	OFF	Open	OFF
Power ON All Ok	ON	OFF	OFF	Closed	ON
Grill Removed	ON	OFF	ON	Open	OFF
HV Fault	ON	OFF	ON	Open	OFF
FAN Fault	ON	ON	OFF	Open	OFF
Out of Balance	ON	OFF	Blinking	Open	ON

Table 1. Alarms and LED Status Indicators

The alarm of the Aerostat XC2 is not designed or calibrated to function as a maintenance alarm. If the emitter points are allowed to become extremely dirty, there is the possibility that the Ionization fault alarm will start to intermittently turn on. If this happens, clean the emitter points following the procedures described in Section 4.2 Emitter Cleaning.

The optional audible alarm will sound upon any alarm condition.

An alarm condition may be caused by any of the following:

- Failed high voltage power supply
- Dirty Emitter points
- No power to the Fan Unit
- Fan in locked-rotor condition or fan failed
- Emitter cartridge not installed or not seated correctly

In the event an Alarm condition occurs, the FMS output relay will open.

For information on troubleshooting alarms, see **Section 4.4 Troubleshooting**.

3.5 FMS Relay Contact

The Aerostat XC2 provides an opto-isolated relay contact for indicating alarm status to your process equipment or facility monitoring system (FMS).

- Relay Open - Blower is in alarm or Power is Off
- Relay Closed - Normal Blower operation

The "FMS Relay Contact" connector on the rear panel of the Blower provides access to the relay contacts. The relay contacts are rated for a maximum of 60 VDC, 0.20A. A mating plug and two crimp-on male pins are provided with the Blower so the end-user can construct an appropriate connecting cable.

Mating plug: Molex #3062023

Crimp-on Pins: Molex #02-06-2101

Crimp tool: Molex #63811-1000 or #63819-1300

<u>Pin</u>	<u>Function</u>
1	Relay Contact 1
2	Relay Contact 2

Table 2. FMS Pinout Designations



Figure 8. FMS Relay Contact Connector on Rear Panel

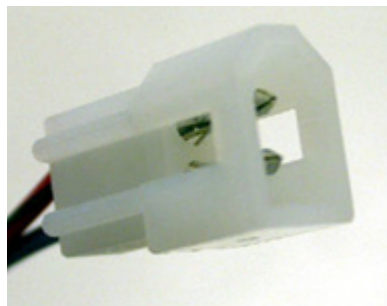

Figure 9. Mating Plug to FMS Connector

3.6 Optional Air Filter

For extremely dirty or dusty environments, an optional air filter kit is available. The air filter kit includes a 30 ppi polyurethane open cell foam air filter that mounts over the rear fan guard using a stamped metal frame and a separate set of sheet metal screws. No disassembly of the original rear fan guard is required. The foam air filter can be cleaned and reused. Simco-Ion also offers a replacement filter pack (see Section 5.3 Parts and Accessories).

When using the optional fan filter, the performance of the unit will be reduced between 10-40% depending upon speed of the blower and the distance to the target.

4

Maintenance

- 4.1 Maintenance Scheduling
- 4.2 Emitter Cartridge Inspection & Cleaning
- 4.3 Chassis Cleaning
- 4.4 Troubleshooting

4.1 Maintenance Scheduling

The balance of the Model Aerostat XC2 is designed to be maintained by internal circuitry and after initial set-up, should not need further adjustment by the end-user.

The XC2 requires little or no user maintenance other than periodic cleaning of the emitter points with the push button cleaner or more extensive cleaning of the emitter cartridge, case and fan.

Simco-Ion recommends using the push button emitter point cleaner daily. This will insure the Aerostat XC2 is fully emitting the maximum volume of ions onto your target area.

Maintenance schedules will vary depending on environmental conditions. Therefore, determine a schedule which meets the requirements of your application and environment.

Before performing any of the following cleaning, be sure the Aerostat XC2 is powered off and unplugged.

To avoid personal injury or damage to the equipment, do not perform any maintenance other than that contained in these instructions.

Caution:

There are no user servicable parts inside this Blower other than the input power fuse and the replaceable emitter cartridge. Any unauthorized service will void the warranty and may result in additional repair charges.

Avant d'effectuer l'une des opérations suivantes le nettoyage, assurez-vous que le Aerostat XC2 est hors tension et débranchée.

Attention: Pour éviter tout risque de blessure ou de détérioration du matériel, n'effectuez aucune opération d'entretien autres que celles contenues dans ces instructions.

Il n'y a aucun utilisateur les pièces internes cette soufflerie autres que l'alimentation d'entrée fusible et l'émetteur remplaçables par cartouche. Tout service non autorisé annulera la garantie et peut entraîner des charges de réparation.

4.2 Emitter Cartridge Inspection & Cleaning

Recommended cleaning materials:

- Cleanroom-compatible cleaning cloths
- Cleanroom-compatible cloth swabs (polyester cloth is recommended)
- Cleaning solution of 50% IPA (electronic-grade isopropanol alcohol)/50% de-ionized water
- Clean dry air (CDA)

Emitter Cartridge Cleaning

With the XC2 turned OFF, emitter cleaning can typically be accomplished by manually depressing the emitter cleaner button on the side of the ionized air outlet at the front of the unit to sweep the internal

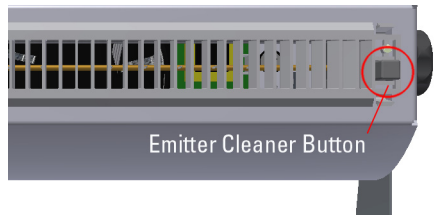

brush over the tips of the emitter points. Depress the button several times (3 to 5 times) to clean the emitter points.

Emitter Cartridge Removal, Cleaning & Replacement

Over time, and depending on the operating environment, dirt and dust may build-up on areas of the ionizer not serviced by the emitter point cleaning brush. This contamination should be removed to ensure optimum operation of the unit. Cleaning the ionizer may help correct minor problems with ion balance and ion output. An intermittent ionization fault light may also indicate the need for cleaning of the ionizer. If the fault light does not go out after operating the emitter point cleaner several times, perform a more thorough cleaning of the ionizer.

To avoid personal injury or damage to the equipment, do not perform any maintenance other than that contained in these instructions.

Caution: Before performing any of the following cleaning, be sure the Model Aerostat XC2 is powered off and unplugged.

DO NOT ATTEMPT TO REMOVE OR INSTALL THE EMITTER CARTRIDGE UNLESS THE BLOWER IS SWITCHED OFF AND DISCONNECTED FROM AC POWER

Avant d'effectuer l'une des opérations suivantes le nettoyage, assurez-vous que le Aerostat XC2 est hors tension et débranchée.

Attention: Pour éviter tout risque de blessure ou de détérioration du matériel, n'effectuez aucune opération d'entretien autres que celles contenues dans ces instructions.

NE TENTEZ PAS DE RETIRER OU D'INSTALLER L'ÉMETTEUR CARTOUCHE SAUF SI LE SURPRESSEUR EST éteint et débranché de l'alimentation en CA.

Disconnect the power cord from the rear of the XC2.

Use a small flat blade screwdriver to unscrew the retaining screws at each end of the emitter cartridge. Pinch the retaining tabs at each end of the ionized air outlet and withdraw the emitter cartridge from the XC2.

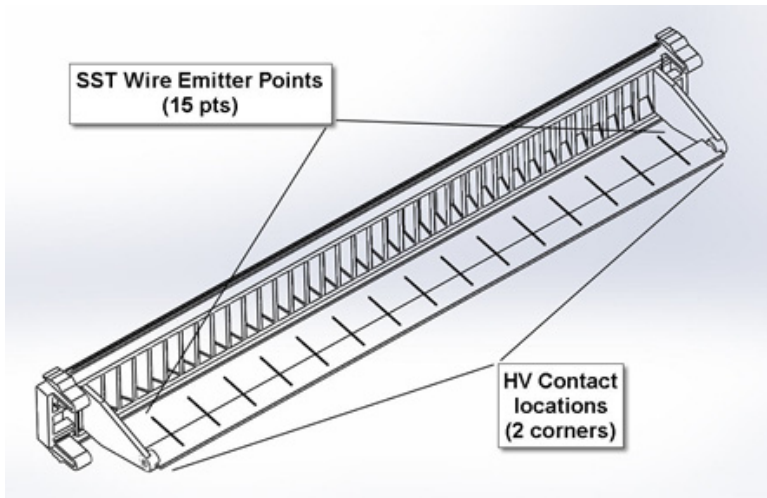
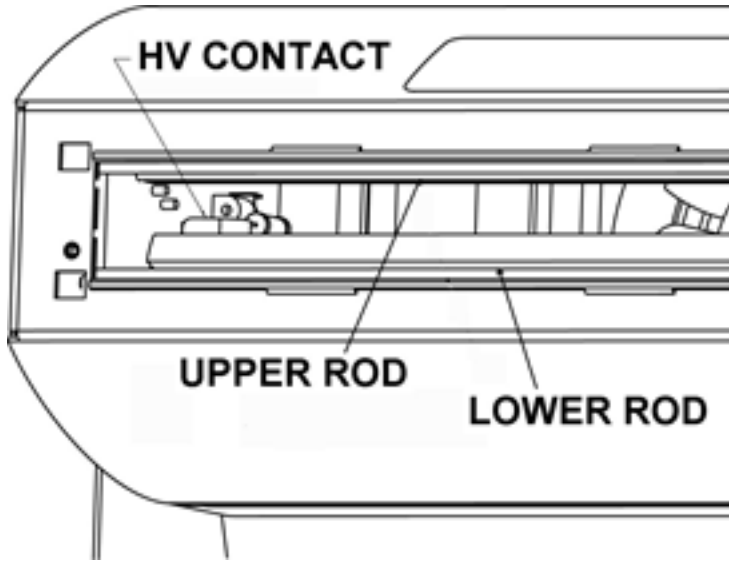

Figure 10. Emitter Cartridge Removal, Cleaning & Replacement

Using the recommended cleaning materials, gently clean the stainless steel (SST) wire emitter points in the cartridge and clean the rear contact corners on the back edge of the emitter assembly plate. Do not bend the emitter wires during cleaning. Periodically inspect the tips of the emitter wires in the emitter cartridge for signs of dirt buildup on the tips or other notable degradation.

Inside the black air duct, use a swab moistened with 50% IPA to clean the two HV spring contacts that are mounted on the side panels of the duct.

Use cleaning cloths moistened with 50% IPA solution to clean the upper and lower steel rods that lay inside the outlet of the duct. Note that the lower rod also serves as the spine of the internal emitter point cleaning brush.



The air inlet fan guard on the rear of the XC2 and the louvered ionized air outlet should remain clean to prevent any restriction of air flow. They can be cleaned with a soft brush, a vacuum or blown off with compressed clean dry air.

Use clean, dry compressed air to clean dust or dirt from the inside of the black air duct.

Allow the cleaned components to completely dry before re-installing.

Examine the cleaned emitter cartridge. Verify that all fifteen of the wire emitter points are projecting straight out and that they are all on the same horizontal plane as the metal plate. Note that all of the wire points are welded to one side of the metal plate.

Install the emitter grill assembly back into the XC2 while noting the following:

- a. The side of the emitter assembly with the emitter wire weld spots should be facing **DOWN** toward the cleaning brush in the chassis.

- b. Insert the correctly oriented cartridge into the XC2. Verify that the emitter assembly seats and the four corner snap locks engage.
- c. Press in the cleaning brush button and visually verify that the tips of all of the emitter wires are swept by the brush as it rotates upward.
- d. Use a small flat blade screw driver to secure the emitter cartridge to the chassis using the captive screws on the ends of the cartridge.

Reconnect line cord to unit and turn the XC2 on. Allow the XC2 to run for at least five minutes before using it to ionize your target area.

Simco-Ion offers a replacement emitter cartridge for the XC2 if it becomes damaged. See the Parts and Accessories section at the end of this manual.

4.3 Chassis Cleaning

Moisten a cleanroom cloth with the diluted IPA solution. Thoroughly wipe down the XC2 chassis to remove any accumulated dirt. Change the cloth frequently to make sure the dirt is completely lifted.

4.4 Troubleshooting

The table below provides a quick troubleshooting reference for the Aerostat XC2. If the solutions listed do not remedy the problem, contact Simco-Ion Technical Support (techsupport@simco-ion.com).

Problem	Possible Cause	Solution
Fan Unit is noisy or slow	Fan is obstructed	Check fan guards for any obstructions
Fan Unit does not operate	Poor power connection or fan is obstructed	Check power cords and connections Check fan guards for obstructions
Offset balance is >10V	Emitter points are dirty	Clean the emitter points
Decay times are too long	Emitter points are dirty	Clean the emitter points
Fault Alarm Blinks intermittently	Emitter points are dirty	Clean the emitter points
FAN Alarm is on continuously	Fan has stopped	Check fan guards for any obstructions
Fault Alarm is on continuously	Possible HV failure or fan has stopped	Contact Simco-Ion for service

Table 3. Troubleshooting

The Model XC2 is provided with a 250V, Time-lag, 5 x 20 mm fuse located in a fuse drawer on the power inlet module.

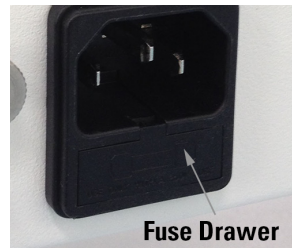

Caution: Turn OFF the Model XC2 and disconnect it from power before attempting to access the fuse drawer.

Attention: Désactiver le modèle XC2 et débranchez-le de la source d'alimentation avant de tenter d'accéder à le tiroir à fusibles.

Replace the fuse only with an identically rated part. If replacing the fuse does not restore the unit to operation, leave the unit turned OFF and disconnected from power. Contact Simco-Ion technical support for additional information.

- 100-230 VAC, 50/60 Hz, 0.5A, 55W max. (no heater); fuse = 2.5A SLO
- 100-120 VAC, 50/60 Hz, 3.5A, 420W max. (with heater); fuse = 5A SLO
- 220-230 VAC, 50 Hz, 1.9A, 460W max. (with heater); fuse = 2.5A SLO

5





Specifications

5.1 Specifications

5.2 Dimensional Drawing

5.3 Parts & Accessories

5.1 Specifications

Input Voltage	100-230 VAC, 50/60 Hz, 0.5A, 55W max (no heater); Fuse: 2.5A 100-120 VAC, 50/60 Hz, 3.5A, 420W max (with heater); Fuse: 5A 220-230 VAC, 50 Hz, 1.9A, 460W max (with heater); Fuse: 2.5A
Discharge	1.0 sec @ 1' (1000-100V high fan speed) ¹
Balance	0 ±10V
Effective Coverage	3'W x 6'L area
Ion Emission	Micropulse AC Ionization
Emitter Points	Stainless Steel
Controls	POWER ON/OFF, FAN SPEED control LOW/MEDIUM/HIGH, Emitter Point Cleaner Push Button, Heater ON/OFF (optional), Balance Adjust
Indicator Lights	Green POWER on, red FAN STALL alarm, red FAULT alarm
Connectors	IEC AC Power Cord inlet, FMS relay contact connector (60 VDC, 0.20A max)
Audible Alarm	Piezo buzzer sounds on any alarm condition (on those models ordering this feature)
Air Volume	110 cfm (low), 150 cfm (high fan speed)
Air Velocity²	620 fpm @ 12", 435 fpm @ 24", 325 fpm @ 36", 265 fpm @ 48" (high fan)
Audible Noise	65 dB (low fan speed), 73 dB (high fan speed) measured at 2' in front of blower
Ozone	<0.05 ppm measured at 1' (305 mm) in front of blower
Cleanliness	Optimum long-term stability is achieved in ISO 14644-1 Class 6 (Fed. Std. 209E Class 1000) cleanrooms or better
Operating Env.	Temperature 50-95°F (10-35°C); humidity 30-60% RH, non-condensing
Fuse	2.5A or 5A 250V, Time-lag, 5 x 20 mm (see Input Voltage information above)
Mounting	Powder Coated Steel Stand with skid resistant rubber feet
Enclosure	Powder-coated aluminum chassis
Air Filter (option)	30 ppi open cell foam filter with bracket
Dimensions	14.13W x 7.2H x 6.55D in (35.9W x 18.3H x 16.6D cm) with stand
Weight	Under 7 lbs (3.2 kg) with stand
Warranty	2 year limited warranty
Certifications	   

1. Tested in accordance with ANSI/ESD STM3.1-2015.

2. High fan speed; Velocity in fpm measured at center line of air stream.

5.2 Dimensional Drawing

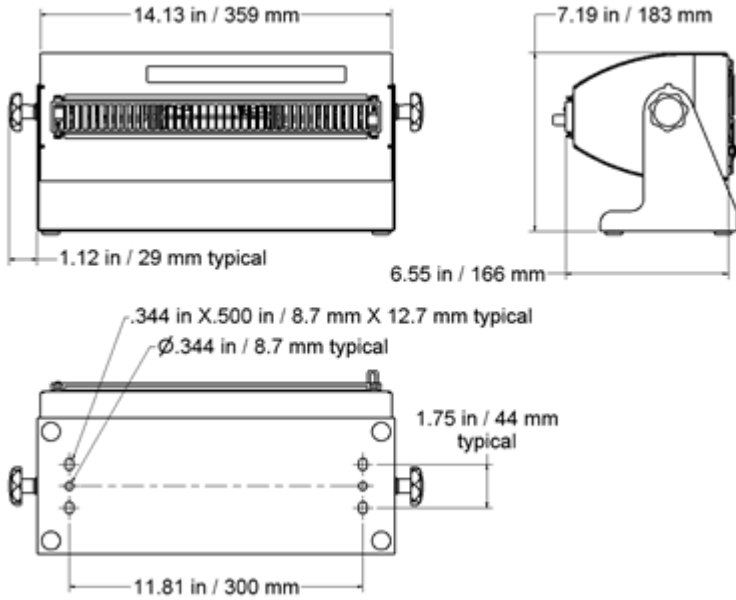

5.3 Parts & Accessories

Contact your Simco-Ion representative or Simco-Ion Sales Services department at saleservices@simco-ion.com or +1 510.217.0460 for more information about these replacement parts and accessories.

33-6002-01	Aerostat XC2 Replacement Emitter Cartridge
33-6003-01	Aerostat XC2 Air Filter Kit
33-6004-01	Aerostat XC2 Air Filter Replacement Pack (6 filters)

6

Warranty & Service

Simco-Ion provides a limited warranty for the Aerostat XC2 Extended Coverage Ionizing Blower. New products manufactured or sold by Simco-Ion are guaranteed to be free from defects in material or workmanship for a period of two (2) years from date of initial shipment. Simco-Ion liability under its new product warranty is limited to servicing (evaluating, repairing, or replacing) any unit returned to Simco-Ion that has not been subjected to misuse, neglect, lack of routine maintenance, repair, alteration, or accident. In no event will Simco-Ion be liable for collateral or consequential damages. Consumable items such as, but not exclusive to, emitter points, emitter wires, batteries, filters, fuses or light bulbs are only covered under this warranty if found defective as received with the new product.

To obtain service under this warranty, please contact Simco-Ion Technical Support at techsupport@simco-ion.com or +1 510-217-0470.



Technology Group

1601 Harbor Bay Pkwy, Ste 150
Alameda, CA USA 94502
Tel: +1 510-217-0600
Fax: +1 510-217-0484
Toll free: +1 800-367-2452
Sales services: +1 510-217-0460
Tech support: +1 510-217-0470

ioninfo@simco-ion.com
saleservices@simco-ion.com
techsupport@simco-ion.com
service@simco-ion.com
www.simco-ion.com